

# presenter



PRESENTER is OE's mobile TV unit , powered by our patented QIKPAC battery, part of the award winning ANIMATE solution

PRESENTER can be configured with up to 4 QIKPAC batteries offering up to 9 hours of cord-free usage. Position PRESENTER where needed without worrying about finding a wall power socket or the annoyance of railing cables.

PRESENTER includes QIKPAC batteries and High-Power USB-C charging ports to charge your laptop, PRESENTER-TV enables true mobility in an agile world.

PRESENTER can be charged by simply plugging to the AC input connector at the base.

Patented - ANIMATE modular battery system



## USPs

- Mount up to a 50" TV/Monitor
- Optional, adjustable shelf
- Available in black
- Castors for easy movement

\*Actual product may differ from that shown, please ask at time of enquiry for up to date information

# technical

Dimensions without TV

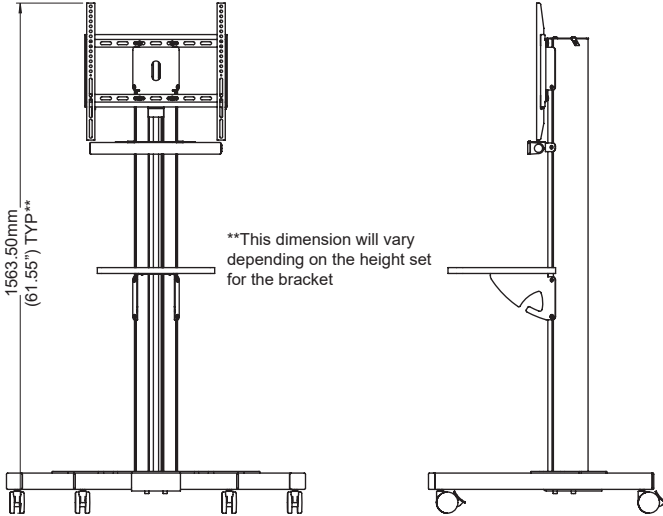
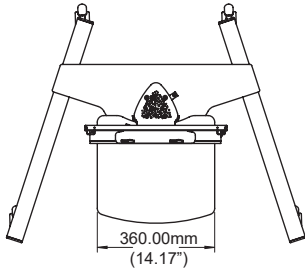

## Dimensions with TV

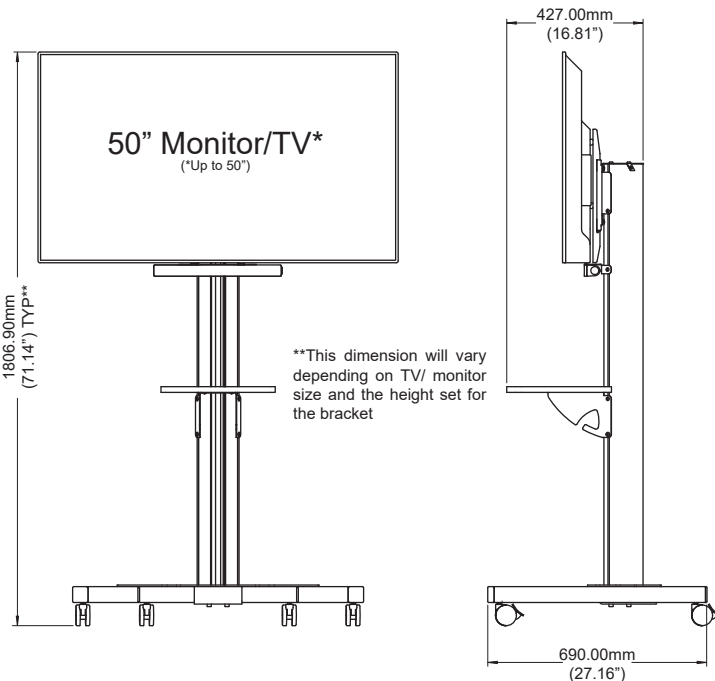

### Construction

Powder coated aluminium extrusion, steel base and top cap

### Colours

Black

### Power connections:

QF05 IEC

Wieland GST08 50V 6A DC power in and out connectors

### Charging Options

QF30 PSU for in-situ charging

### USB charger options

Optional integrated QF05 TUF HP

### Shipment

QIKPAC batteries are shipped by OE in UN38.3 certified dangerous goods packaging.

### Recycling

End of life QIKPACs should be recycled in accordance with prevailing regulations for the recycling of portable li-ion battery packs in the country of use

### Quality & Testing

All PRESENTER units are manufactured using ISO9001 quality controlled components and practices and are fully tested before dispatch"

### CE/UKCA marking

PRESENTER is CE and UKCA marked by OE Electrics as complying with:

- EU Battery Directive 2006/66EC as amended by 2013/56/EU
- Electromagnetic Compatibility Directive 2014/30/EU
- ROHS Directive 2011/65/EU as amended by 2015/863/EU plus the equivalent UK regulations

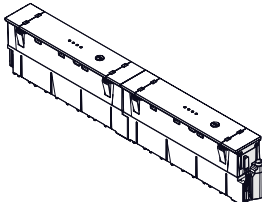
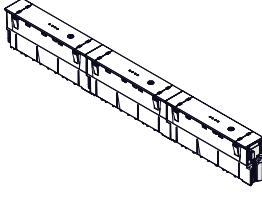
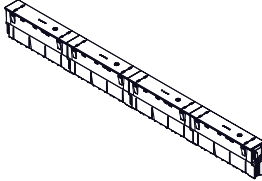
No of Batteries	Runtime (Based on a 43" TV)
	4 hours
	6 hours
	8 hours

# technical

## PRESENTER Options

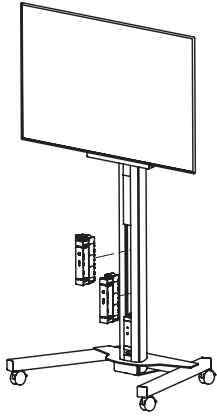

2 x QIKPAC Batteries

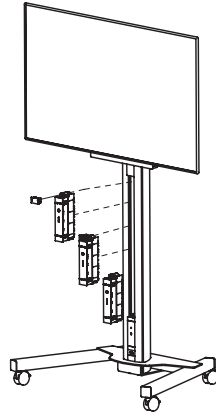

3 x QIKPAC Batteries

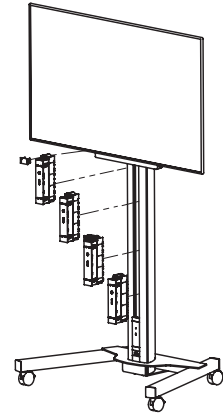

4 x QIKPAC Batteries





PRESENTER TV can include up to 4 batteries depending on requirements needed



Optional, adjustable shelf to safely place laptops and mobile phones

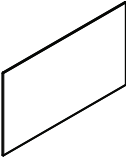

PRESENTER TV can include TUF-R HP to power laptops that can then also be connected for presentations. Runtime may vary when using TUF-R HP to power or charge a laptop.

PRESENTER Recommendations		
	QIKPAC Battery BLACK	<i>Fit up to four QIKPAC depending on usage</i>
	GST08 Converter (Built into unit)	
	Model No: 42 inch SONY Bravia TV. (19Vdc)	For monitor / TV options please inquire.

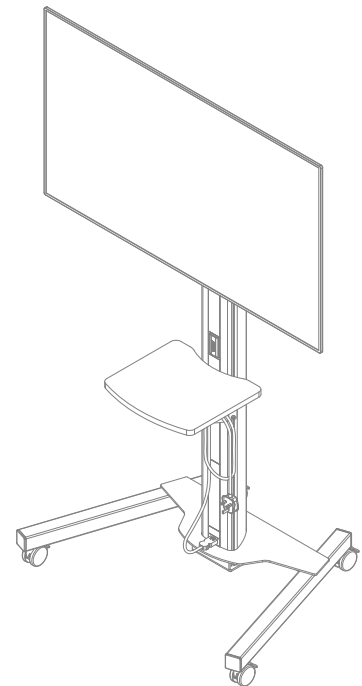

Tethered (non-battery) solution